

Pressure intensifiers are used wherever a particular section of a hydraulic system has to be pressurized to a substantially higher pressure than the available primary pressure (clamping functions). With an intensification ratio of 1 : 4 (1 : 2) it enables a cost-effective system solution especially in clamping applications, with primary pressures up to 125 bar. A pilot operated check valve can be flanged underneath the pressure intensifier for quick filling and decompression of the high pressure section.

Features

- Mounting pattern NG06, DIN 24 340 Design A, CETOP, ISO
- Check valve attachable to bottom flange
- High pressure up to 500 bar
- Volume flow formed with low pulsation
- Compact design

Design

Main functional parts of the pressure intensifier: piston, rocker mechanism, slide valve with lock, 4 check valves which separate the high pressure section from the low pressure section, check valve in the tank port to partition of the tank section from the primary pressure.

Function

After the high pressure section is filled with oil, (e.g. extension of a clamping cylinder), the pressure intensifier begins operation: The low pressure moves the intensifier piston because of the surface ratio and compresses the oil column in the high pressure section.

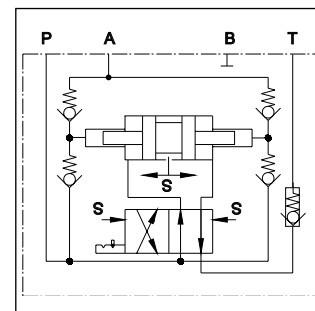
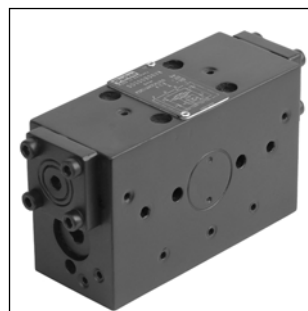

At the end of the intensifier's piston stroke, the rocker mechanism switches the directional slide valve to the crossed switching position, and the intensifier piston pumps oil from the piston rod area into the high pressure section. The process repeats itself until the pressure ratio corresponding to the surface ratio has led to a balance of force on the intensifier piston.

The pressure intensifier switches itself off and immediately on again when the high pressure (e.g. due to external leakage) begins to drop (pay attention to the flow characteristic). The switching speed of the slide valve is dependent on the operating speed of the intensifier piston.

Note

- To avoid exceeding the admissible maximum pressure, a pressure relief or pressure control valve must be fitted on the primary side (pressure setting, max. 125 bar / 1 : 4, max. 250 bar / 1 : 2).
- There must be no pressure peak on the primary side when operating in the maximum pressure range.
- It is recommended to mount a 10µm filter on the primary side to ensure damage-free operation.

Ordering code

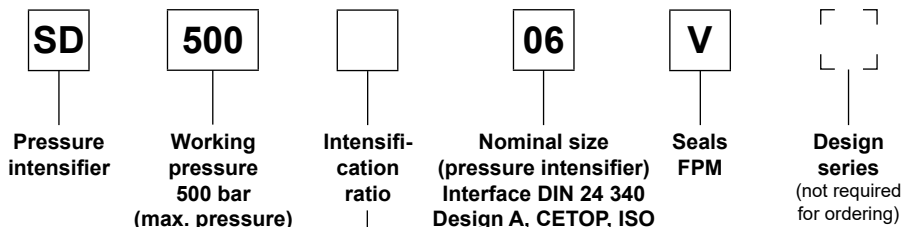

Code	Intensification ratio
A	1 : 4
B	1 : 2

Bold letters = Short-term availability

Technical data



General	
Symbol	DIN 24 300
Design	Piston and poppet valve in body
Mounting type	NG06, DIN 24 340, design A, CETOP, ISO
Ports	Subplate
Mounting position	unrestricted
Ambient temperature	[°C] -20...+60
MTTF _D value	[years] 150
Weight	[kg] 3.0 kg
Hydraulic	
Max. operating pressure	Port A [bar] 500, Port P, B, T [bar] 125 (ratio 1:4), 250 (ratio 1:2)
Fluid	Hydraulic oil according to DIN 51524
Fluid temperature	[°C] +10...+70
Viscosity, permitted	[cSt] / [mm ² /s] 20 ... 400
recommended	[cSt] / [mm ² /s] 30...80
Filtration	ISO 4406; 18/16/13
Flow	see performance curve
Intensification ratio	$p_P : p_A = 1 : 4, 1 : 2$
Flow volume	$Q_P : Q_A = 4 : 1, 2 : 1$
Stroke volume	[cm ³] 3 (per double stroke)
Operating	Hydraulic-mechanic automatic control

Accessories

Type	Description	Number
SD 500*06V	Seals	
	9.25 x 1.78	3
	10.82 x 1.78	1
	M5 x 75 ISO 4762-12.9	4

Seals are included in delivery.
 Mounting screws are not included in delivery.

12

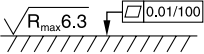
Surface finish	 Kit		
	BK401	4x M5x75 ISO 4762-12.9	9.0 Nm

Flow characteristics

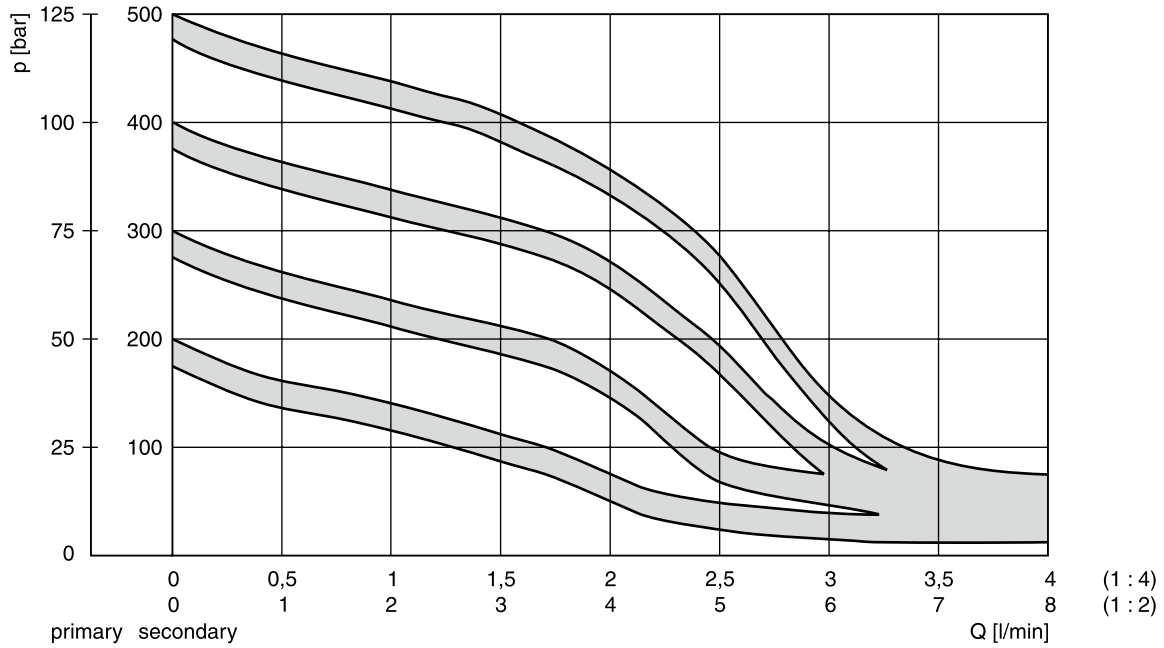

Approximate values of the compression time for compressing a filled volume to target pressure (1 : 4)

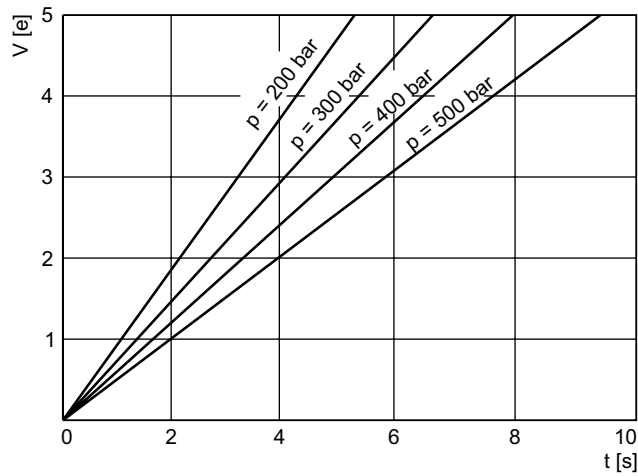

All characteristic curves measured with HLP46 at 50 °C.

Dimensions

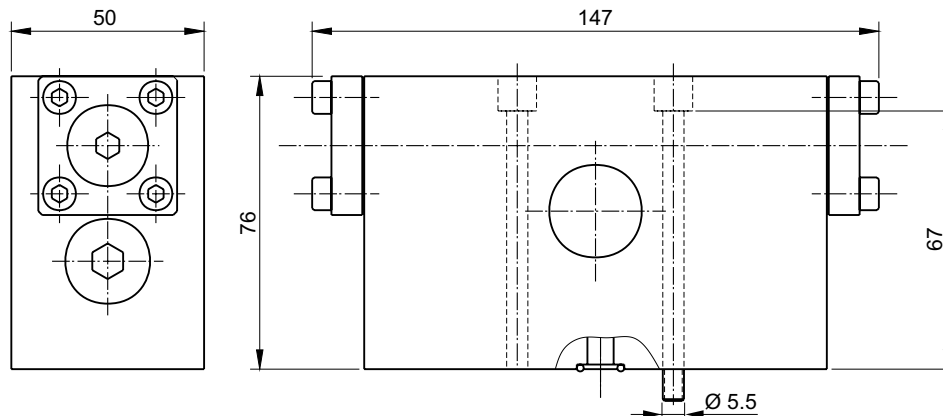

Pilot operated check valve plate NG06

Description

Pilot operated check valve plates are flanged under the pressure intensifier for quick filling and decompression.

Design

The check valve plate is equipped with a hydraulic, pilot operated check valve.

Opening ratio: Main valve 2.5 : 1

Pilot ratio 10 : 1

Ordering code

H06 SDV

Bold letters =
Short-term availability

Accessories

Type	Description	Number
H06SDV	Seals	
	9.25 x 1.78	4
	M5x115 ISO 4762-12.9	4

Seals are included in delivery.

Mounting screws are not included in delivery.

Technical data

General	
Design	Spring loaded ball seat valve
Mounting type	Flange
Mounting position	any
Ambient temp. [°C]	-20...+60
Weight [kg]	1.3
Hydraulic	
Operating pressure range	
Port A [bar]	max. 500,
Port P, B, T [bar]	max. 125 / 1:4 and 250 / 1:2
Fluid	Hydraulic oil according to DIN 51524
Fluid temperature [°C]	+10...+70
Viscosity, perm. [cSt] / [mm ² /s]	20...400
recom. [cSt] / [mm ² /s]	30...80
Filtration	ISO 4406 (1999); 18/16/13
Flow	see characteristic curve
Pilot ratio	Main valve 2.5:1, pre-discharge 10:1
Opening pressure [bar]	approx. 0.5

Characteristic curve

Pilot operated check valve

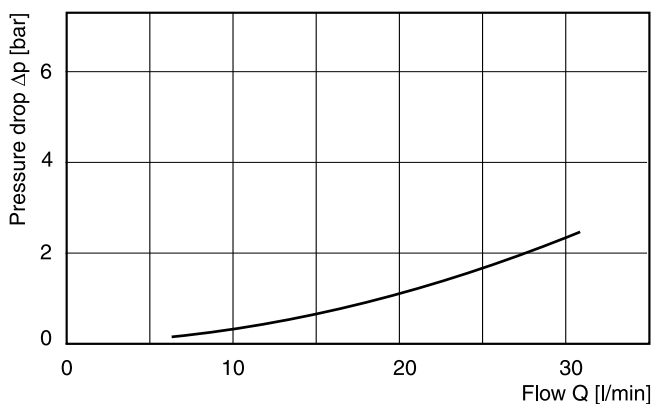

Curve measured with HLP46 at 50 °C.

Dimensions

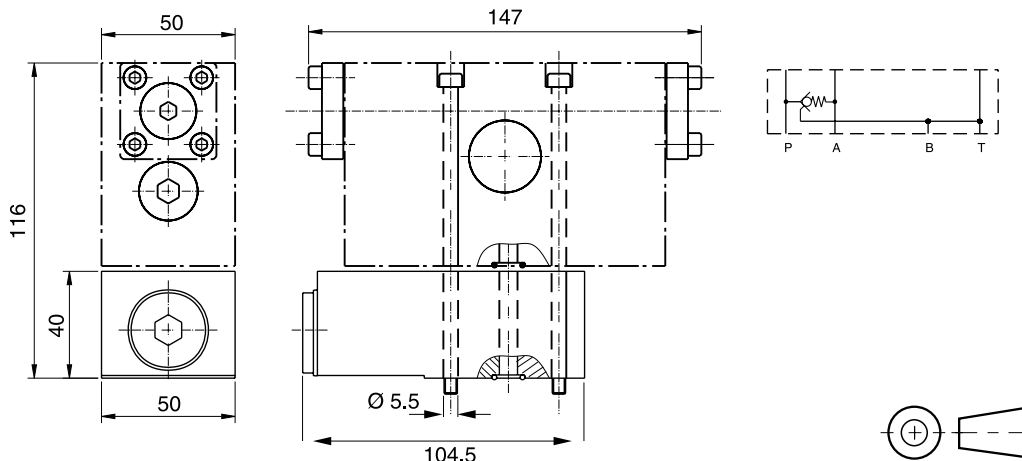

Surface finish	Kit	4x M5x115 ISO 4762-12.9	9.0 Nm
	BK406		

Pilot operated check valve plate NG10

Description

Pilot operated check valve plates are flanged under the pressure intensifier for quick filling and decompression.

Design

The check valve plate is equipped with a hydraulic, pilot operated check valve.

Opening ratio: Main valve 2.5 : 1

Pilot ratio 10 : 1

Technical data

General	
Design	Spring loaded ball seat valve
Mounting type	Flange
Mounting position	any
Ambient temp. [°C]	-20...+60
Weight [kg]	2.3
Hydraulic	
Operating pressure range	
Port A [bar]	max. 500,
Port P, B, T [bar]	max. 125 / 1:4 and 250 / 1:2
Fluid	Hydraulic oil according to DIN 51524
Fluid temperature [°C]	+10...+70
Viscosity, perm. [cSt] / [mm ² /s]	20...400
recom. [cSt] / [mm ² /s]	30...80
Filtration	ISO 4406 (1999); 18/16/13
Flow	see characteristic curve
Pilot ratio	Main valve 2.5:1, pre-discharge 10:1
Opening pressure [bar]	approx. 0.5

Ordering code

H10 SDV

Accessories

Type	Description	Number
H10SDV	Seals	
	12.24 x 1.78	4
	M5x75 ISO 4762-12.9	4
	M6x50 ISO 4762-12.9	4

Seals are included in delivery.

Mounting screws are not included in delivery.

Characteristic curve

Pilot operated check valve

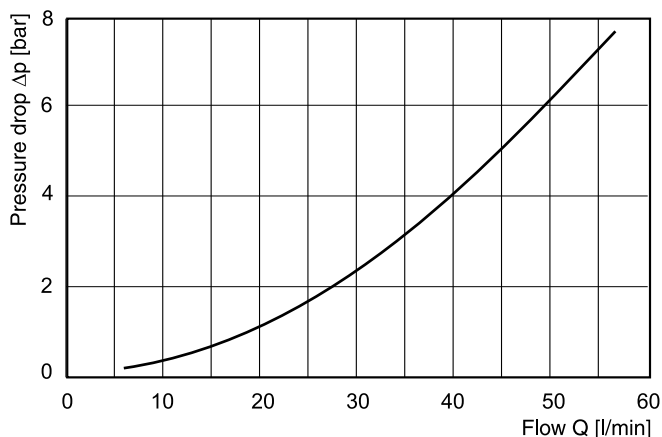

Curve measured with HLP46 at 50 °C.

Dimensions

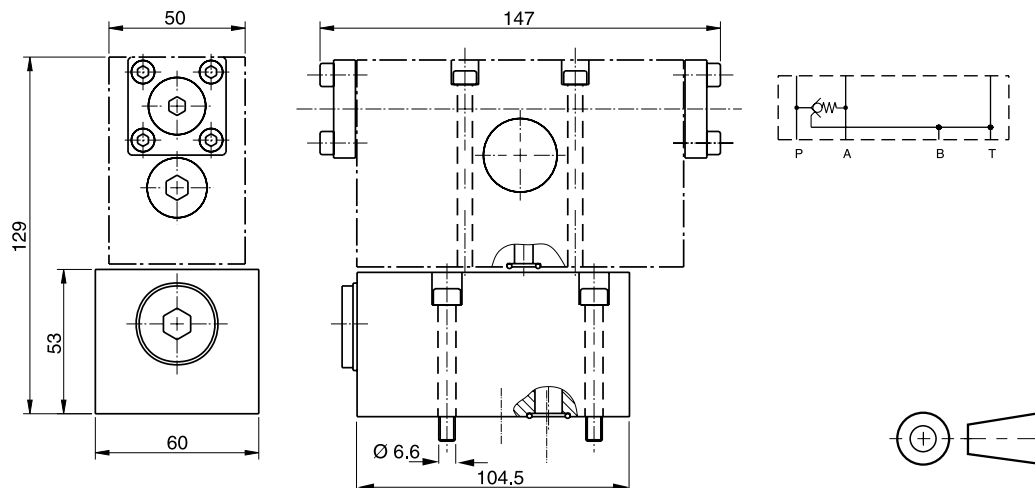

Surface finish	Kit	Kit	Kit
	BK490	4x M5x75 4x M6x50 ISO 4762-12.9	9.0 Nm 18.0 Nm

